

Sherpack 120



COD: 158.003

Aurilis Group

14 -16 Rue Pierre Boulanger -63100 Clermont Ferrand -France

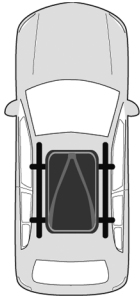
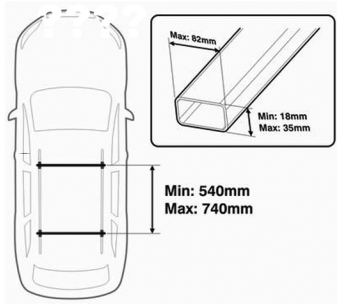

✓
OK

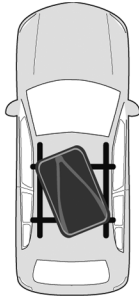

✗
NO



✓ **OK**

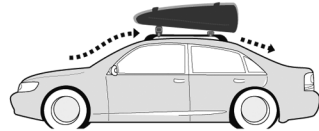

✗ **NO**

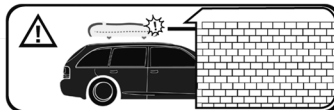
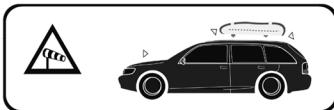
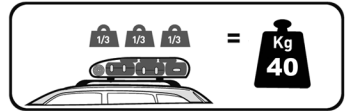
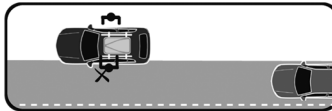
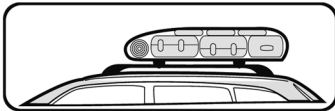

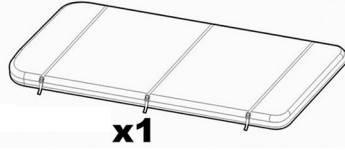
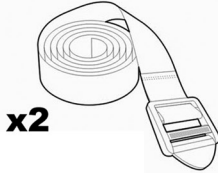
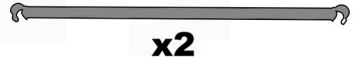
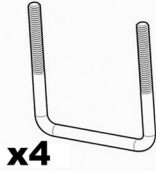

1

x1

A)

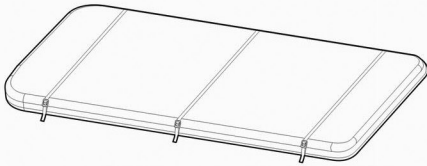

B)

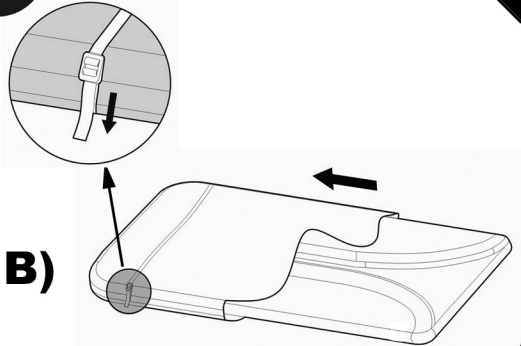

A)

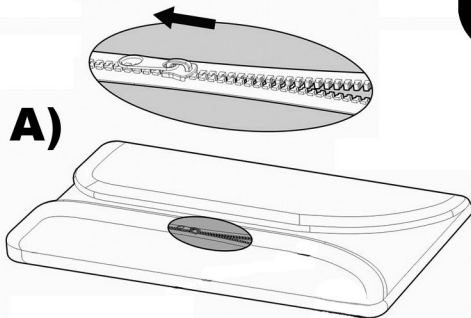

2

x1

B)

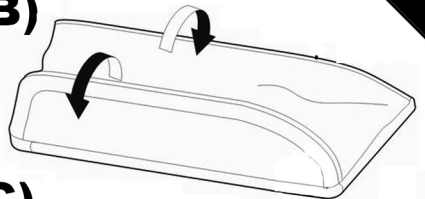

C)

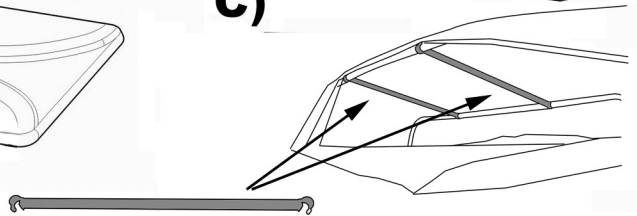

x4

3

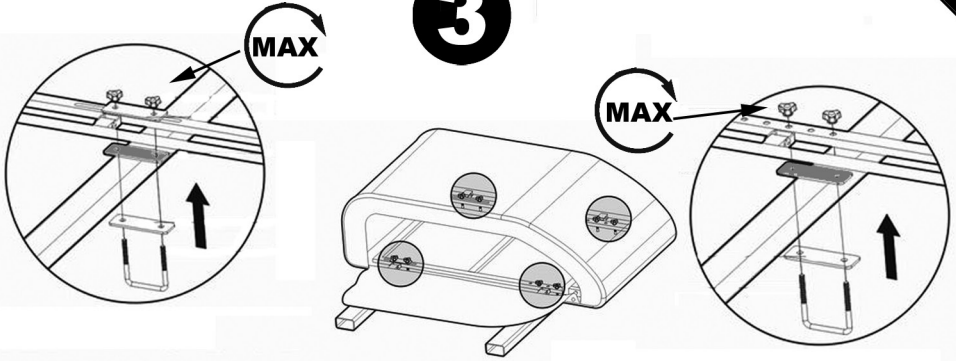

4

x1

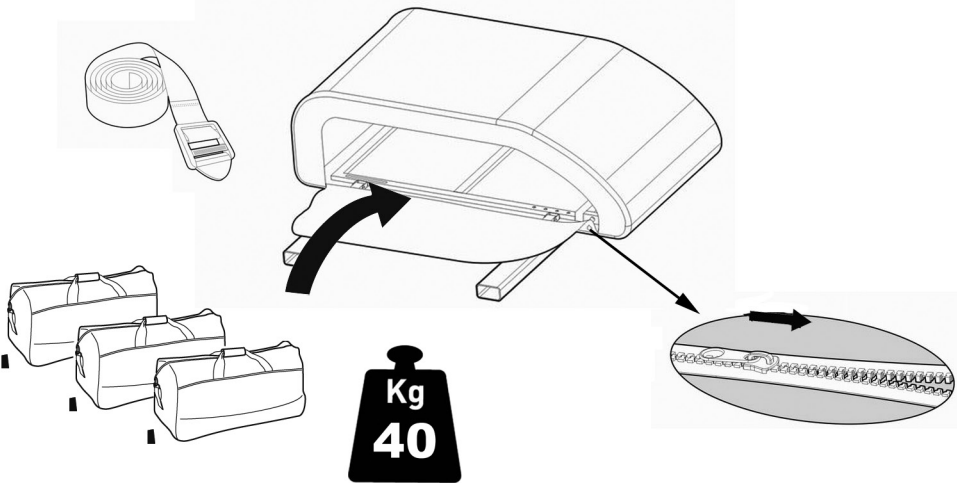

1

x1

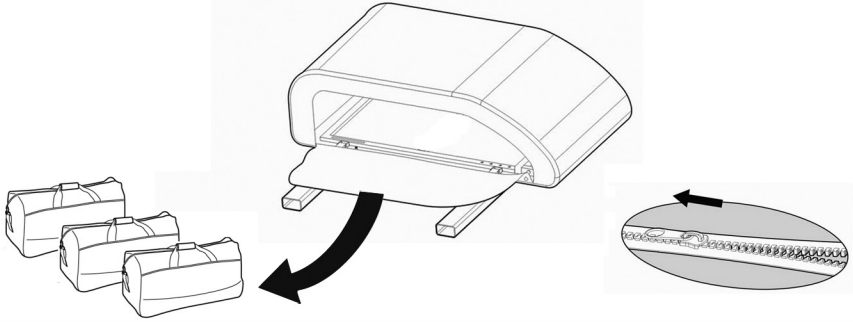

2

x1

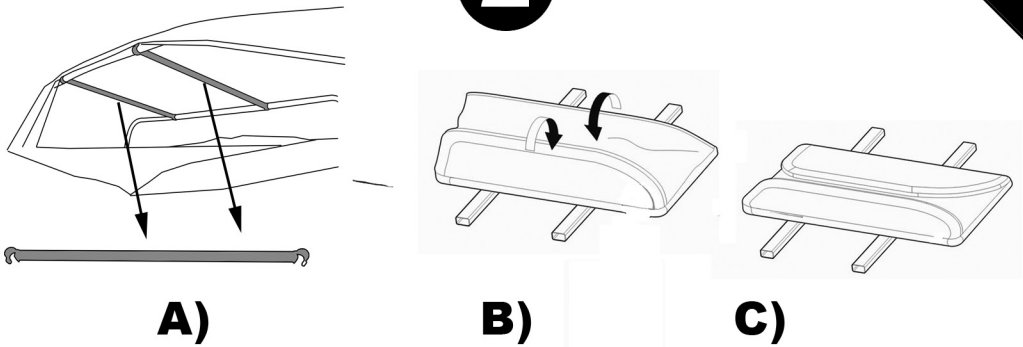

3

x1

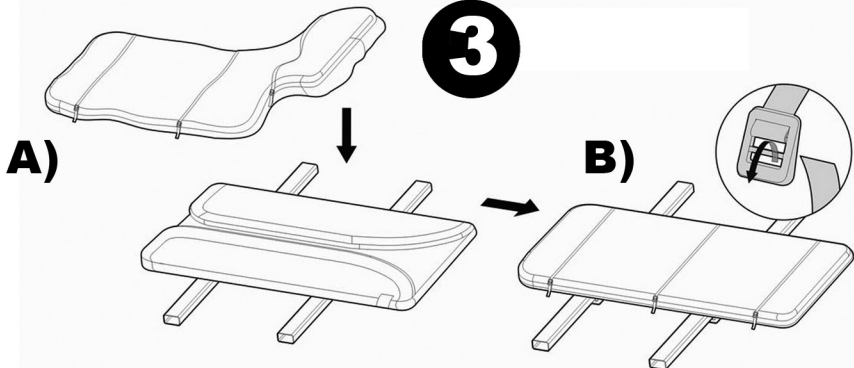

1

x4

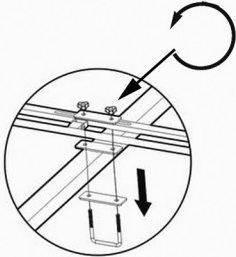

x2

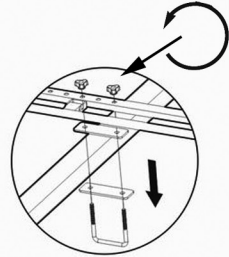
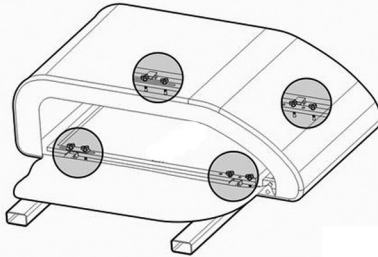

x2

2

x1

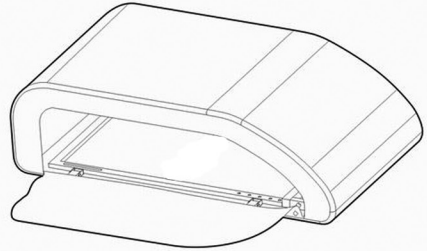
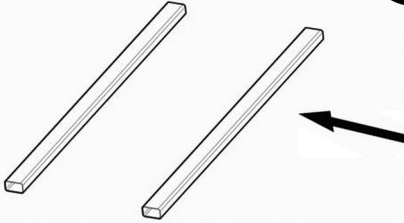

3

x1

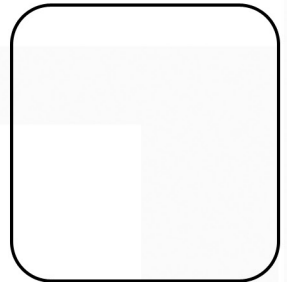
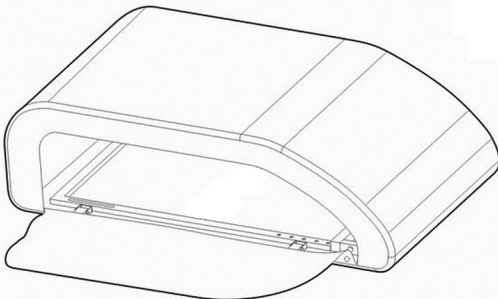

FR

- Il est important de suivre correctement les instructions de montage et d'utilisation
- Les sangles élastiques avec crochets de fixation ne doivent pas être utilisées
- Toute charge transportée sur le pavillon d'un véhicule affecte d'une manière sensible son comportement, en particulier la sensibilité au vent latéral et le comportement en virage ou au freinage
- Il est conseillé de conduire avec plus de prudence (réduire la vitesse, tenir compte de l'augmentation des distances de freinage)
- Afin de réduire la consommation de carburant, il est conseillé d'ôter les barres porte- charges de toit après utilisation
- ! Ne pas rouler avec le coffre de toit vide
- Le coffre de toit doit être positionné avec l'ouverture des fermetures à glissières à l'arrière du véhicule
- Vérifier régulièrement le serrage des fixations pendant le trajet
- Respecter la charge maximum de 50kg ou la charge indiquée par le constructeur si celle ci était inférieure
- Ne pas déposer le coffre s'il est chargé
- Il est important d'entretenir correctement son matériel : Le nettoyage peut être fait avec une éponge humide et un détergent doux

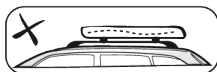
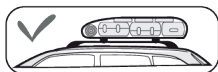

ESP

- ¡No circule con la baca vacía!
- La baca debe estar colocada con la apertura de los cierres deslizando en la parte posterior del vehículo
- Compruebe periódicamente el apriete de las fijaciones durante el trayecto
- Respete la carga máxima de 50 kg o la carga indicada por el constructor, si ésta es inferior
- No desmonte la baca si está cargada
- La limpieza debe realizarse únicamente con una esponja y un detergente suaves.

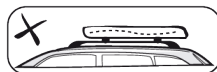
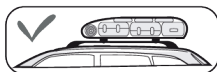

ITA

- E molto importante seguire correttamente le istruzioni di montaggio e di utilizzo
- Le cinghie elastiche con gancio non devono essere utilizzate
- Tutto il carico trasportato sul tetto del veicolo incide sensibilmente sul comportamento della vettura, in particolare in condizioni di vento laterale ed il comportamento in curva ed in frenata
- Al fine di ridurre il consumo di carburante, è consigliato smontare le barre portatutto dopo l'utilizzo
- ! Non utilizzare l'auto con il box da tetto vuoto
- Il box da tetto deve essere posizionato con l'apertura delle chiusure a cerniera rivolta verso il retro del veicolo
- Verificare regolarmente il serraggio degli attacchi durante il tragitto
- Rispettare il carico massimo di 50 kg o il carico indicato dal costruttore, qualora inferiore.
- Non togliere il box da tetto quando carico
- Pulire con una spugna inumidita e detergente leggero

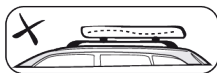
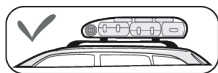

P

- ! Não circular com a bagageira de tejadilho vazia
- A bagageira de tejadilho deve ser posicionada com a abertura dos fechos de correr na traseira do veículo
- Verificar regularmente o aperto das fixações durante o trajeto
- Respeitar a carga máxima de 50 kg ou a carga indicada pelo fabricante, no caso de esta ser inferior
- Não retirar a bagageira se esta estiver carregada
- A limpeza pode ser realizada com uma esponja húmida e um detergente suave

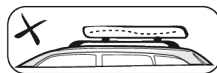
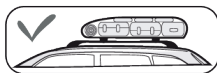

ENG

- It is important to follow instructions for use
- Do not use elastic straps
- A vehicle's handling (particularly resistance to side winds, cornering ability and braking performance) is greatly affected when loads are placed on its roof. Use extra caution when driving under such conditions (slower speeds and longer braking distances required)
- For greater fuel efficiency, remove the bars when not in use
- ! Do not drive with an empty roof box on your vehicle.
- Place the roof box so that the zippers are at the rear when closed.
- During your journey, regularly check the tightness of the mounting points.
- Do not fill to over the maximum load (50 kg or less, depending on the manufacturer).
- Do not remove a loaded box.
- Servicing your equipment properly is important: Clean with a damp sponge and mild detergent.

N

- ! Niet rijden met een lege dakkoffer
- De dakkoffer met de opening van de ritsluitingen aan de achterkant van het voertuig plaatsen
- De bevestigingen regelmatig controleren tijdens de rit
- De maximale belasting van 50 kg of de belasting van de fabrikant aanhouden als deze kleiner is
- De dakkoffer niet geladen demonteren
- De dakkoffer reinigen met een vochtige spons en een zacht wasmiddel

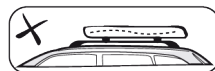
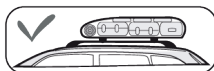
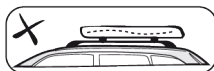
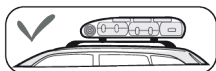

GER

- Nicht mit der leeren Dachbox auf dem Dach fahren!
- Die Dachbox ist stets mit der Öffnungsseite nach hinten auf dem Dach zu montieren
- Bei längeren Strecken regelmäßig kontrollieren, ob die Dachbox noch richtig fest sitzt
- Max. Gewicht von 50 kg nicht überschreiten bzw. die Vorgaben des Herstellers einhalten, wenn die Gewichtsvorgaben niedriger sind
- Die Dachbox nur leer herunternehmen
- Reinigung der Dachbox mit einem feuchten Schwamm und sanften Reinigungsmittel

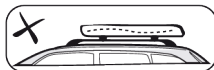
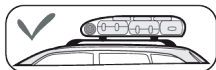

Aurilis Group - 14/16-Rue PierreBoulanger - 63100 - CLERMONT FERRAND
MG - 04/11 - 11158003
www.greenvalley.fr